

ELECTRIC MOTORS
GEARMOTORS AND DRIVES

Installation and Service Instructions for 56/143-5TC Double C-Face Coupler

For replacement parts refer to sheet part number 8-078-906-07. Instructions and parts list also available at www.rexnord.com/stearns.

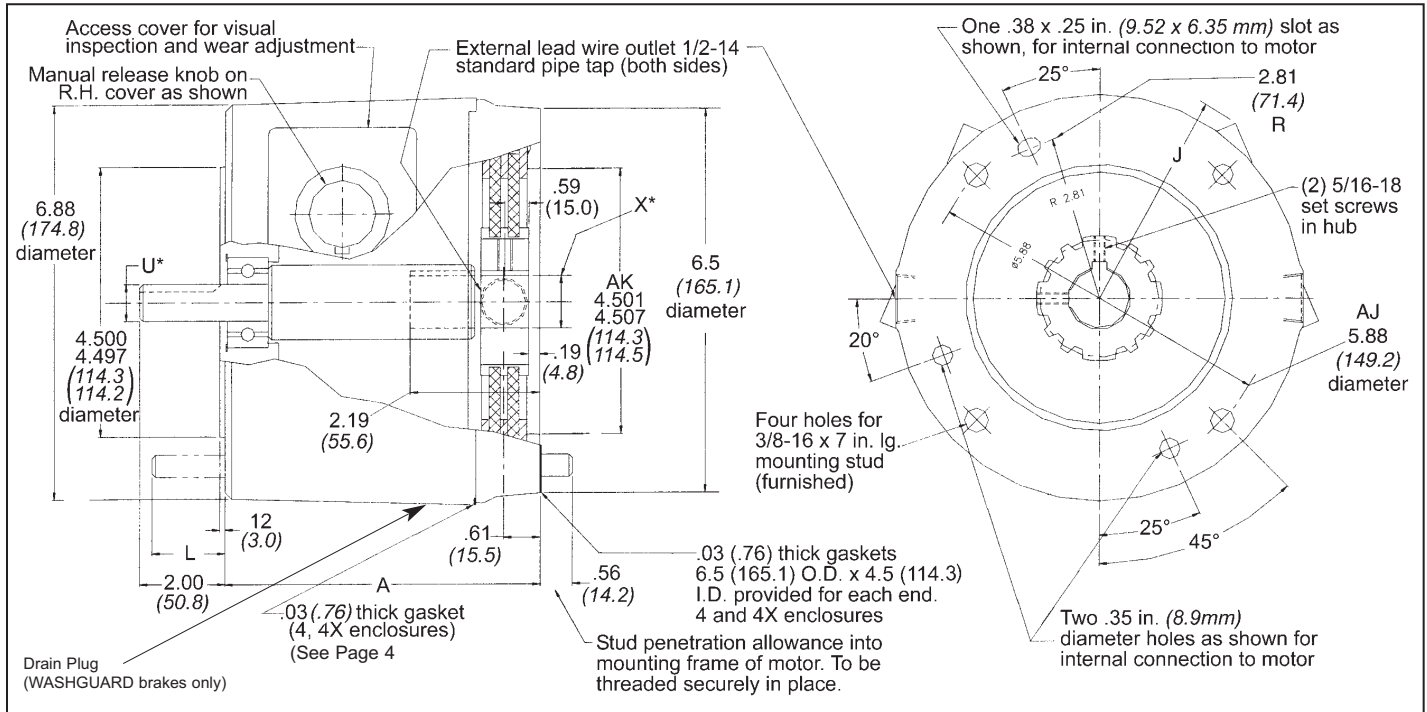

Figure 1

Tools required for installation and servicing:

3/8" hex wrench	5/16" nut driver	5/16" hex wrench	Torque wrench
1/4" screwdriver	3/16" hex wrench	8" adjustable wrench	

Important

Please read these instructions carefully before installing, operating, or servicing your brake. Failure to comply with these instructions could cause injury to personnel and/or damage to property if the brake is installed or operated incorrectly. For definition of limited warranty/liability, contact Leeson Electric Corporation, P.O. Box 241, 2100 Washington Street, Grafton, WI 53024-0241, (262) 377-8810.

Caution

- Installation and servicing must be made in compliance with all local safety codes including Occupational Safety and Health Act (OSHA). All wiring and electrical connections must comply with the National Electric Code (NEC) and local electric codes in effect.
- Do not operate the brake in atmospheres containing explosive gases or dusts.
- To prevent an electrical hazard, disconnect power source before working on the brake. If power disconnect point is out of sight, lock disconnect in the *off*

position and tag to prevent accidental application of power.

- Make certain power source conforms to the requirements specified on the brake nameplate.
- Be careful when touching the exterior of an operating brake. Allow sufficient time for brake to cool before disassembly. Surfaces may be hot enough to be painful or cause injury.
- Do not operate brake with housing removed. All moving parts should be guarded.
- Installation and servicing should be performed only by qualified personnel familiar with the construction and operation of the brake.
- For proper performance and operation, only genuine Stearns parts should be used for repairs and replacements.
- After usage, the brake interior will contain burnt and degraded friction material dust. This dust must be removed before servicing or adjusting the brake.
DO NOT BLOW OFF DUST using an air hose. It is important to avoid dispersing

dust into the air or inhaling it, as this may be dangerous to your health.

- Wear a filtered mask or a respirator while removing dust from the inside of a brake.
 - Use a vacuum cleaner or a soft brush to remove dust from the brake. When brushing, avoid causing the dust to become airborne. Collect the dust in a container, such as a bag, which can be sealed off.
10. **Caution!** While the brake is equipped with a manual release to allow manual shaft rotation, the motor should not be run with the manual release engaged, to avoid overheating the friction disc(s).

Warning! Do not apply overhung or side load to brake output shaft

General Description

The 56,700 Series coupler is a spring-set, electrically released brake, containing either one or more rotating friction discs (4) driven by a hub (16) mounted on the motor shaft. The double C-face allows the brake to directly couple a C-face motor to a C-face gear reducer.

BRAKE MOUNTING (Manual Adjust)

1 Place hub on motor shaft.

2 Position hub on shaft as shown.

.188"
(4.77mm)

3 Tighten set screws to motor shaft.

156 lb-in.

4 A. Remove housing nuts and slide tie bolt out of brake.
B. Remove housing from endplate.

counter-clockwise

5 Slide endplate over hub noting position of stabilizer clips, if used. (Refer to Friction Disc Replacement view 3 and 3A). Mount brake endplate to motor C-face using the four tie bolts. Finger tighten.

6 Connect coil lead-wires to power supply. Refer to nameplate for voltage rating.*
Caution: Keep wiring away from pinch points and moving components.

Coil Wiring

Single Voltage

twist lines 1 & 3

Dual Voltage Coil at Low Voltage

twist lines 2 & 4

Dual Voltage Coil at High Voltage

twist lines 3 & 4 and use wire nut

7 A. Slide housing and shaft assembly onto mounting studs, rotating shaft until keyway is aligned. Be sure housing is assembled with access windows in same position as shown in Figure 1, page 1.
B. Mount and secure brake/motor assembly to C-face mounting register of reducer. Using four 3/8 - 16 nuts and lockwashers, tighten to 30-35 ft-lb.

clockwise

FRICTION DISC REPLACEMENT SERIES

1 Remove support plate screws and lift support from brake

counter-clockwise

2 Remove and discard old friction disc.

3 Install new friction disc(s) and stationary disc(s) as shown.

For brakes with vertical springs see *Vertical Spring Assembly Section*.

3A

*** Stabilizer clips are for use on single disc units only. Position clips opposite set screw holes.**

4 Reposition support plate on endplate and tighten mounting screws to 55 lb-in.

clockwise

Note: Friction discs can wear to 1/2 their original thickness, or .093"

AIR GAP ADJUSTMENT

As friction disc wear the air gap will increase. When plunger gets to the reset position, the air gap must be adjusted.

- 1** To **increase** air gap, turn both adjusting screws (10) counterclockwise.

Air Gap Settings*

Torque (lb-ft)	56,X00 Series
3 & 6	.38" ± .03"
10 & 15	.45" ± .03"

*For reference only

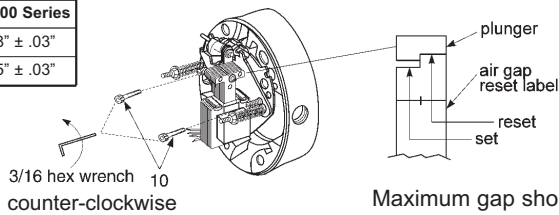

- 2** To **decrease** air gap, turn both adjusting screws (10) clockwise.

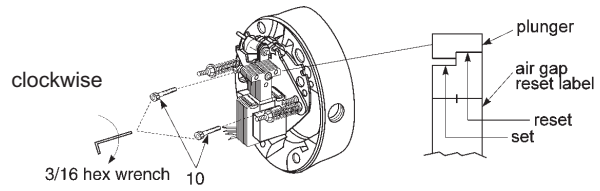

Maximum gap should never exceed .80".

Note: Air gap can be adjusted without disassembly. Remove cover plate (7A) and manual release plate (7B) and adjust as shown above.

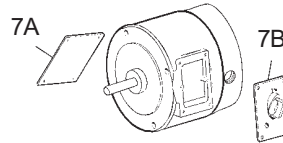

COIL REPLACEMENT SERIES

Remove housing and disconnect power and wiring to coil.

- 1** Insert screwdriver between support plate and lever arm and pry forward.

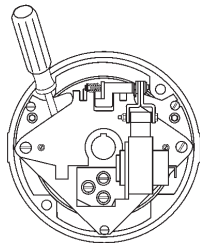

- 2** Lift plunger/solenoid lever assembly out of coil.

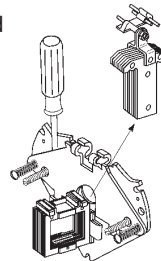

- 3** Remove plunger guide.

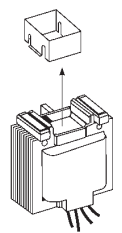

- 4** Discard coil.

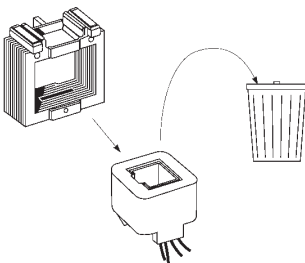

- 5**
A) Insert new coil.
(Lead wires in same position as old coil.)
B) Insert plunger guide.

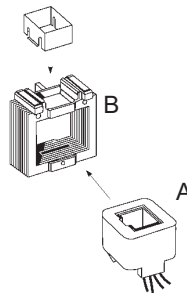

- 6** A) Re-insert plunger into coil; drop pivot pin into cradle of support plate.
B) Remove screwdriver.

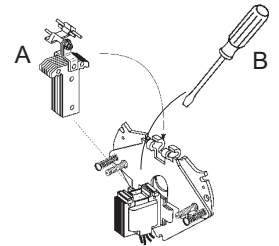

Reconnect coil and replace housing per installation instructions, page 2.

VERTICAL SPRING ASSEMBLY

Vertical Brake Assembly

Single disc brakes (3 & 6 lb-ft) are universal mount and do not require separator springs. Double disc brakes (10-15 lb-ft.) are universal mount but require separator springs which are preassembled to the stationary disc. These discs are inserted spring first into the brake. Refer to figure 2A.

2 Friction Disc

Vertical Above
Vertical Below

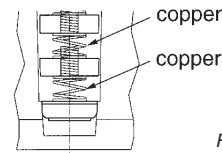

Figure 2A

TORQUE ADJUSTMENT

Torque Adjustment

Brake is factory set for nominal rated static torque which is maximum torque. Torque may be decreased up to 50% for increased stopping times up to 2 second stop time.

Turn both spring adjustment screws (11), Figure 3, equal amounts counterclockwise to decrease torque. See Table A for torque reduction permissible amounts.

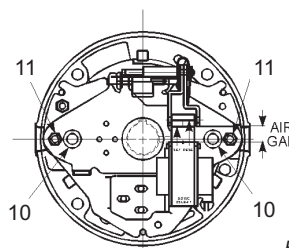

Figure 3

Table A

Nominal Static Torque (lb-ft)	Original Spring Height (inches)	Maximum Counter-clockwise Turns	% Torque Reduction per Turn
3	1.50"	5-1/2	9%
6	1.50"		
10	1.56"		
15	1.56"		

TROUBLESHOOTING

COIL FAILURE	
SUPPLY VOLTAGE CAUSE	SUPPLY VOLTAGE CORRECTION
Line voltage >110% of coil rating	Reduce voltage or replace with proper rated coil
Excessive voltage drop during inrush time	Increase current rating of power supply.
WIRING CAUSE	WIRING CORRECTION
Leadwires interfering with plunger pull-in	Reroute wiring away from plunger and other moving components.
Excessive voltage drop during inrush time	Increase leadwires size from power supply
Coil leadwire shorted to ground	Replace coil or leadwire and protect with wire sleeving
SOLENOID ASSEMBLY CAUSE	SOLENOID ASSEMBLY CORRECTION
Plunger not seating flush against solenoid frame	Loosen solenoid mounting screws and reposition frame to allow full face contact
Plunger cocked in coil preventing pull-in	Realign solenoid frame
Excessive solenoid/plunger wear at mating surface	Replace solenoid assembly
Broken shading coils	Replace solenoid assembly
WORN PARTS CAUSE	WORN PARTS CORRECTION
Excessive wear of solenoid link arm and/or shoulder bolt	Replace link arm and link bolt; also inspect plunger thru-hole for elongation
Plunger guides worn down and interfering with plunger movement	Replace guides
APPLICATION CAUSE	APPLICATION CORRECTION
Machinery cycle rate is exceeding brake rating	Reduce brake cycle rate or use alternate control method
High ambient temperature (>110%) and thermal load exceeding coil insulation rating	Use Class H rated coil and /or find alternate method of cooling brake rating
Brake coil wired with windings of an Inverter motor or other voltage/current limiting device	Wire coil to dedicated power source with instantaneous coil rated voltage
MISCELLANEOUS CAUSE	MISCELLANEOUS CORRECTION
Wrong or over tightened torque	Replace with proper spring or refer to Installation section for proper spring height
Excessive air gap	Reset, refer to Installation Section 4

EXCESSIVE WEAR / OVERHEATING	
AIR GAP CAUSE	AIR GAP CORRECTION
Low solenoid air gap	Reset air gap (refer to Air Gap Adjustment)
Disc pack dragging	Inspect endplate, hub and discs for dirt, burrs, wiring and other sources of interference preventing disc "float"
CYCLE RATE CAUSE	CYCLE RATE CORRECTION
Brake "jogging" exceeding coil cycle rate	Reduce cycle rate or consider alternate control method
Thermal capacity is being exceeded	Reduce cycle rate, use alternate control method or increase brake size
ALIGNMENT CAUSE	ALIGNMENT CORRECTION
Broke endplate not concentric to motor C-Face	Motor register must be within .004" on concentricity;
Motor shaft runout is excessive	Must be within .002"; runout; consult motor manufacturer
Brake is being operated on a incline greater than 15° above or below horizontal	Vertical separator springs must be used to prevent discs from becoming cocked
WORN PARTS CAUSE	WORN PARTS CORRECTION
Friction disc excessively worn (disc can wear to 1/2 original thickness or .093")	Replace friction discs.
Endplate, stationary disc or pressure plate warped	Replace warped or worn component
Linkages and/or pivot pins worn	Replace all worn components
Motor shaft endfloat excessive	Endfloat must not exceed .020"; consult motor manufacturer
HUB CAUSE	HUB CORRECTION
Burr on hub interfering with disc "float"	File off burr
Set screw backed out and interfering with disc	Retighten set screw; use Loctite® 242 to help secure
MISCELLANEOUS	MISCELLANEOUS
Solenoid plunger not pulling completely	Check line voltage (±10% of nameplate rating) or replace worn solenoid assembly
Wiring is restricting disc pack movement	Reroute wiring
Excessive stop time (2 seconds or greater)	Increase brake size/torque or use alternate control method
High Ambient temperature (in excess of 110°F)	Reduce cycle rate or use alternate method of cooling
Moisture in brake	Remove drain plug (WASHGUARD brakes only). After fluid has drained replace plug

PART NUMBERS	Torque lb. ft.	Leeson Part Number	Stearns Part Number	Brake Coil Rating (VAC)	NEMA Enclosure	Brake Bore/ Shaft Diameter (X/U)	NEMA Frame Size	Dimension A
3	175563.00	1056711051PF	115/208-230	2	5/8" / 5/8"	56C	4.91"	
	175564.00	1056711051QF	208-230/460	2	5/8" / 5/8"	56C	4.91"	
	175565.00	1056711051NF	575	2	5/8" / 5/8"	56C	4.91"	
	175566.00	1056714051PF	115/208-230	4X	5/8" / 5/8"	56C	4.94"	
	175567.00	1056714051QF	208-230/460	4X	5/8" / 5/8"	56C	4.94"	
	175568.00	1056714051NF	575	4X	5/8" / 5/8"	56C	4.94"	
6	175569.00	1056721081PF	115/208-230	2	7/8" / 5/8"	56C/143-5TC	4.91"	
	175570.00	1056721081QF	208-230/460	2	7/8" / 5/8"	56C/143-5TC	4.91"	
	175571.00	1056721081NF	575	2	7/8" / 5/8"	56C/143-5TC	4.91"	
	175572.00	1056724081PF	115/208-230	4X	7/8" / 5/8"	56C/143-5TC	4.94"	
	175573.00	1056724081QF	208-230/460	4X	7/8" / 5/8"	56C/143-5TC	4.94"	
	175574.00	1056724081NF	575	4X	7/8" / 5/8"	56C/143-5TC	4.94"	
10	175575.00	1056731081PF	115/208-230	2	7/8" / 5/8"	56C/143-5TC	4.91"	
	175576.00	1056731081QF	208-230/460	2	7/8" / 5/8"	56C/143-5TC	4.91"	
	175577.00	1056731081NF	575	2	7/8" / 5/8"	56C/143-5TC	4.91"	
	175578.00	1056734081PF	115/208-230	4X	7/8" / 5/8"	56C/143-5TC	4.94"	
	175579.00	1056734081QF	208-230/460	4X	7/8" / 5/8"	56C/143-5TC	4.94"	
	175580.00	1056734081NF	575	4X	7/8" / 5/8"	56C/143-5TC	4.94"	
15	175581.00	1056741071QF	208-230/460	2	7/8" / 7/8"	143-5TC	4.91"	
	175582.00	1056744071QF	208-230/460	4X	7/8" / 7/8"	143-5TC	4.94"	